

HTR News

Haustüren-Ring GmbH, Januar 2011



2011 Stark durch Service

Der Vorsprung liegt im Detail!

Innovation durch Design und Technik.

Green Building

- ▶ Nachhaltigkeit
- ▶ Energieeinsparung
- ▶ Umweltschutz

Öko-Passiv
98 mm
Passivhaus
zertifiziert

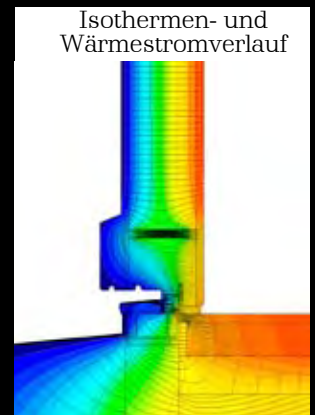
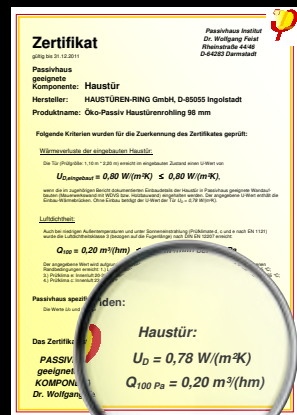

Öko-Energy
78/88 mm



Sicherheit

Neue und umfangreiche WK2 Prüfung

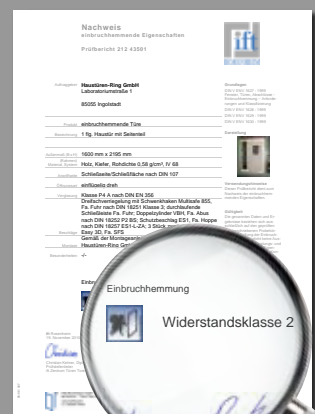

Brandschutz

Haustüren

Klassifizierung und Prüfung nach:

EI₂ 30 C (T30)

EN 13501-2 EN 1363-1 EN 1634-1



IBS Linz Klassifizierungsbericht
Nr. 09111221

Glashalteleisten Holz

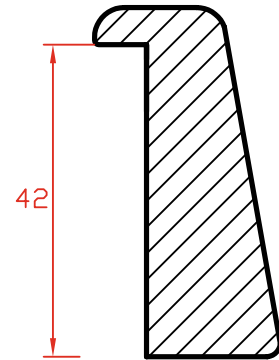
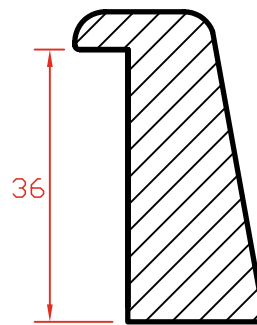
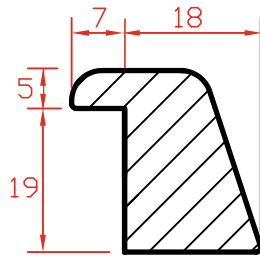
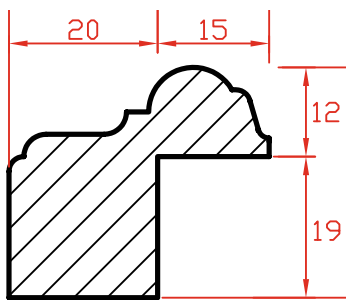

□ Quadrat

□ Rechteck

◁ Dreieck

○ Kreis/Bullauge

~ Napoleonhut

~ Segmentbogen

◐ Kreisabschnitt

Eiche

Fichte

Kiefer

Meranti

Lärche

Edelstahlrahmen 50 mm

- Quadrat
- Rechteck
- Kreis/Bullauge
- Sockelblech



EN 14351-1:A1

Neutrale
Überwachung
+ Zertifizierung
Außentürenrohlinge
Nr. 182 6050855
ift Rosenheim

Vertrieb + Verkauf

HAUSTÜREN-RING GmbH

Laboratoriumstraße 1

D-85055 Ingolstadt

Telefon +49 (0) 8 41 - 95 49 95

Telefax +49 (0) 8 41 - 9 54 99 99

Internet: www.haustueren-ring.de

E-Mail: office@haustueren-ring.de

